

TRT800H-LCD

Mode-S

Transponder



P/N 800ATC-H-(2xx)-(26x)

Operation and Installation

(Dokument-Nr. 03.2126.010.71e)

Change History

Revision	Date	Description of Change
1.00	18.03.2016	First Release from SW V6.0
2.00	22.10.2019	Extended configuration options for GPS Protocol and remote control interface. Accuracy and integrity value selection added

List of Service-Bulletins (SB)

Service Bulletins have to be inserted into this manual and to be enlisted in the following table.

SB No	Rev. No.	Issue Date	Insertion Date	Name
SB TRT800-A-H-1	1.04	17.10.2008		

Table of Contents

1	GENERAL.....	5
1.1	Symbols	5
1.2	Abbreviations	6
1.3	Customer Support	6
1.4	Features.....	7
1.5	Deviations and Important Notes	8
2	OPERATION.....	9
2.1	Controls.....	9
2.2	Switch ON/OFF	11
2.3	Display - Indications	12
2.4	Display-Brightness	13
2.5	Flight-ID (FID)	13
	2.5.1 Display Flight-ID	13
	2.5.2 Configure Flight-ID	14
2.6	Transponder Mode selection.....	14
2.7	Squawk-Setting.....	15
2.8	VFR – Squawk	15
2.9	ID – Special Position Identification (SPI): “Squawk Ident”	16
2.10	Error-Codes	16
3	INSTALLATION	17
3.1	Notes	17
3.2	Telecommunication data	17
3.3	Scope of Delivery	17
3.4	Unpacking and Inspecting of the Equipment	18
3.5	Mounting	18
3.6	Equipment Connections	19
	3.6.1 Electrical Connections	19
	3.6.2 Static Air Port.....	20
3.7	Wiring.....	20
	3.7.1 Conductor Cross Section.....	20
	3.7.2 Pin Assignment.....	21
	3.7.3 Cable plan External Memory EM800	22
3.8	Antenna.....	25



3.8.1	Antenna Selection	25
3.8.2	Installation Recommendation.....	25
3.8.3	Antenna Wiring.....	26
3.9	Post-Installation Check.....	26
3.10	Starting Up	27
3.11	Accessories.....	27
3.12	Drawings	28
3.12.1	Dimensions.....	28
3.12.2	Mounting Advices	28
4	Transponder SETTINGS.....	29
4.1	Overview	29
4.2	Display Configuration Summary	29
4.3	General settings.....	31
4.3.1	ICAO 24-Bit Aircraft Address (AA)	31
4.3.2	Aircraft Category (AC)	32
4.3.3	Flight-ID (FID).....	32
4.3.4	Reply Information - Speed Category (RI).....	33
4.4	Optional settings	33
4.4.1	Option Ground-Switch	33
4.4.2	Option Remote Header.....	34
4.4.3	Altitude Correction/Offset.....	37
4.5	Setup Procedure	38
4.5.1	Setup Menu Control.....	38
4.5.2	Transponder configuration/record structure	39
4.5.3	Transponder configuration/record handling	39
4.5.4	General Setup	39
4.5.5	Altitude Correction Setup.....	43
5	APPENDIX.....	45
5.1	Technical Data	45
5.2	Environmental Conditions	47
5.3	DO-178B Open Problem Reports.....	48

1 GENERAL

This manual contains information about the physical, mechanical and electrical characteristics and about installation and operation of the Mode S Transponder TRT800H.

The conditions and tests required for TSO approval of this article are minimum performance standards. Those installing this article either on or within a specific type or class of aircraft must determine that the aircraft installation conditions are within the TSO standards which include any accepted integrated non-TSO function standards. TSO articles and any accepted integrated non-TSO function(s) must have separate approval for installation in an aircraft. The article may be installed only according to 14 CFR part 43 or the applicable airworthiness requirements. This is an incomplete system (antenna is required) intended to provide the TSO functions specified in this Operation and Installation Manual, section 5.1.

1.1 Symbols

	Advices whose non-observance can cause radiation damage to the human body or ignition of combustible materials
	Advices whose non-observance can cause damage to the device or other parts of the equipment.
	Supplementary information

1.2 Abbreviations

Abb.	Meaning	Explanation
FID	Flight ID	Flight plan number or if not assigned registration number of aircraft
SPI	Special Position Identification	Activation on request by controllers „Squawk Ident“, transmits SPI Pulse for 18 seconds, which highlights the respective traffic item on the controllers radar screen
AA	Aircraft Address	assigned ICAO 24-bit address
AC	Aircraft Category	Defines aircraft type according to specific categories
RI	Reply Information	Maximum airspeed

1.3 Customer Support

In order to facilitate a rapid handling of return shipments, please follow the instructions of the input guide „Reshipment RMA“ provided at the **Service-Area** within the f.u.n.k.e. AVIONICS GmbH web portal www.funkeavionics.de.



Any suggestions for improvement of our manuals are welcome. Contact: service@funkeavionics.de.



Information on software updates is available at f.u.n.k.e. AVIONICS GmbH.

1.4 Features





In order to operate the Mode S transponder it is necessary to request an ICAO 24-bit Aircraft Address at the responsible national aviation authorities. The received Code is assigned to the specific transponder/aircraft and must be configured within the transponder. The 24-bit address is stored in an external memory which allows the transponder being exchanged without requiring any further configuration. (for detailed information refer to sections 4.3.1 and 4.5.4).

- Class 1 Level 2es non-diversity Mode S transponder for ground based interrogations at 1030 MHz and response at 1090 MHz
- Replies to (Secondary) Radar Interrogations
 - Mode A replies with a Squawk (one of 4096 possible Codes; e.g. flight plan number, Squawk assigned by a controller or the VFR Squawk 7000)
 - Mode C replies, including encoded flight level
 - Mode S replies, including aircraft address and flight level
 - Extended Squitter, containing additional information on position and velocity
- IDENT capability for activating the Special Position Identification“-Pulse (SPI) for 18 seconds, which is requested by the Controller „Squawk Ident“
- Maximum flight level 35 000 ft; maximum airspeed 250 kt
- Display information contains Squawk code, mode of operation and pressure altitude.
- Temperature compensated high precision piezo-resistive pressure sensor
- RS-232 I/O data port enabling connection with certain GPS- Receivers in order to support ADS-B Out
- 8 storable entries for AA-/AC-Code, FID, Ground-Switch, RI-Code and GPS-/Interface-setting (stored in external memory TRT800EMxx)
- Remote control unit interface

1.5 Deviations and Important Notes

The following deviations have been granted by the FAA:

	The device is certified to FAA TSO-C112c in lieu of FAA TSO-C112d.
---	--

	Environmental Qualification Testing was performed according to RTCA/DO-160D in lieu of RTCA/DO-160F.
---	--

	The Software of this device was developed according to RTCA DO-178B Design Assurance Level "D".
--	---

	The ADS-B function of this device has not been evaluated during the FAA TSO certification process other than to ensure non-interference. Due to the SW assurance of DAL "D", the ADS-B function cannot be used in the US National Airspace. Connecting a GPS source will not comply to FAA certification requirements with regard to ADS-B.
---	---





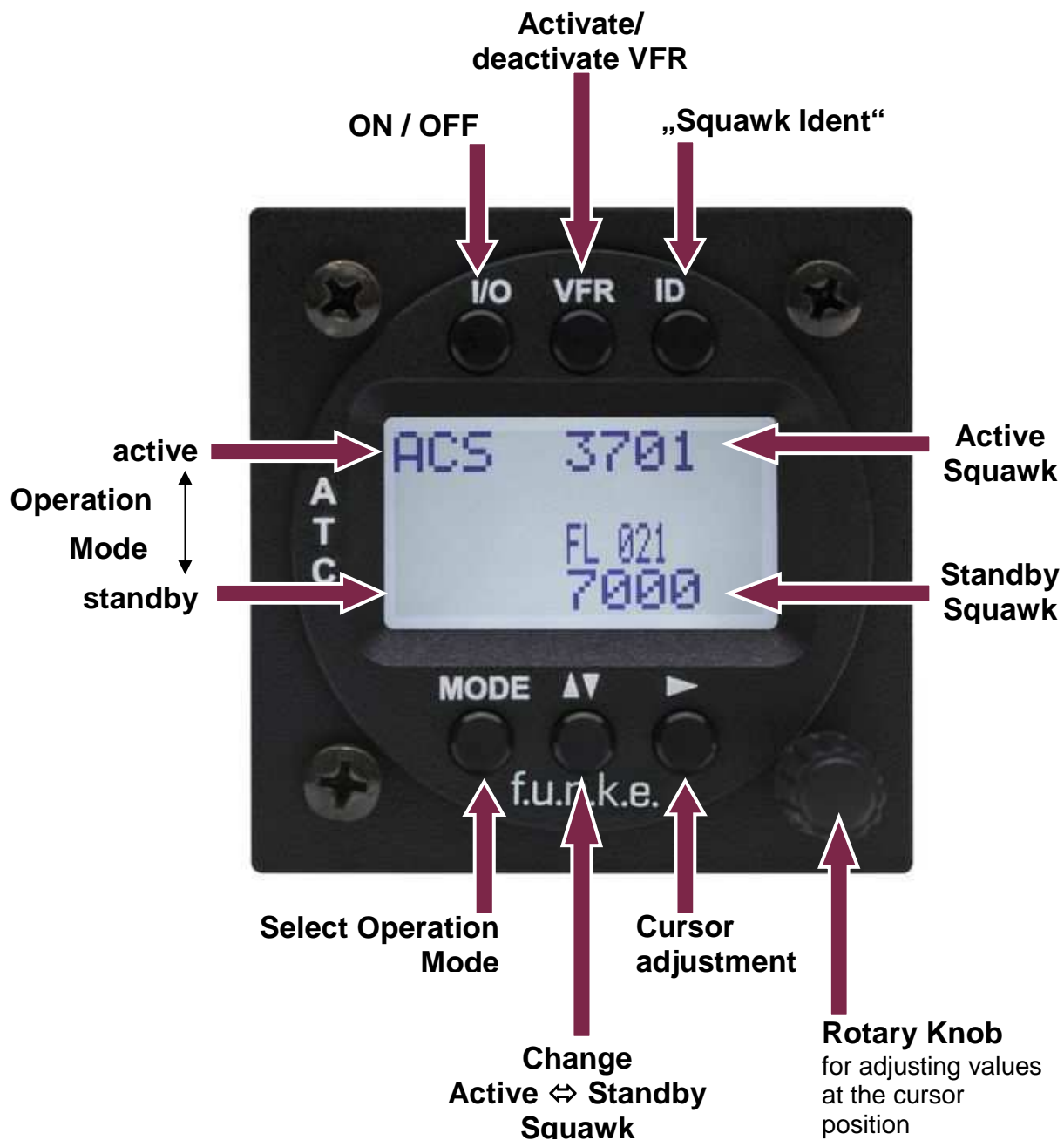

	This device contains an altitude measuring device that has not been evaluated during the FAA TSO certification process other than to ensure non-interference. This feature must be evaluated for intended function during FAA installation approval.
---	--

	Compliance to RTCA DO-181D was verified by testing against EUROCAE ED-73C. The two standards are technically identical with regard to the TRT800H.
---	--

2 OPERATION

2.1 Controls



	ON/OFF	<ul style="list-style-type: none"> ▶ Switch ON press button for approx. 0,5 s ▶ Switch OFFpress button for approx. 3 s
	VFR	<ul style="list-style-type: none"> ▶ activate/deactivate VFR Squawk (press shortly) ▶ store active Squawk as VFR/VFRW-Squawk (press button 3 s, →2.8)
	CHANGE	<ul style="list-style-type: none"> ▶ change between active and standby-Squawk ▶ works as cursor back button (opposite function of the cursor button) during entering values and also for navigating backwards through the configuration menu (→4.5.4)
	IDENT	<ul style="list-style-type: none"> ▶ „Squawk Ident“, sends Ident marking (SPI) for 18 s (→ 2.9) ▶ Enter Flight-ID (FID) setup (in standby mode, press button for approx. 5s)
	MODE	<ul style="list-style-type: none"> ▶ Select transponder operational mode (→ 2.6)
	CURSOR	<ul style="list-style-type: none"> ▶ Set position of Cursor
	Rotary Knob	<ul style="list-style-type: none"> ▶ Adjust/Enter values at current cursor position, select options; set standby Squawk (→ 2.7)

2.2 Switch ON/OFF

Switch **ON**: press ●/I/O for 0.5 s

Switch **OFF**: press ●/I/O for 3 s

2.2.1 Display information after power up

After turning-on the display appears as follows (example):

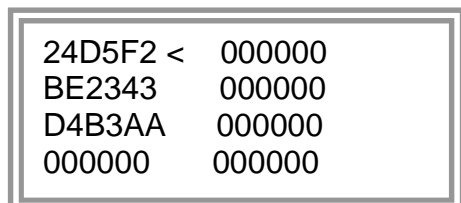
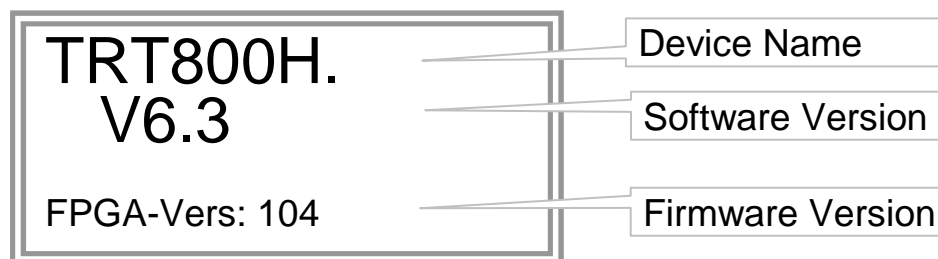

If more than one configuration record is programmed the record selection menu appears (example).

Select the desired record (rotary switch) and confirm with ●**MODE**.



If no external memory is connected or no 24bit address is defined the message “CRADLE OFF” appears. In this case the device is working as “Mode AC only” transponder.

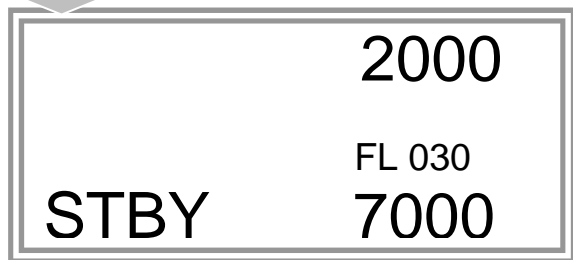

The transponder starts in STBY mode

2.3 Display - Indications

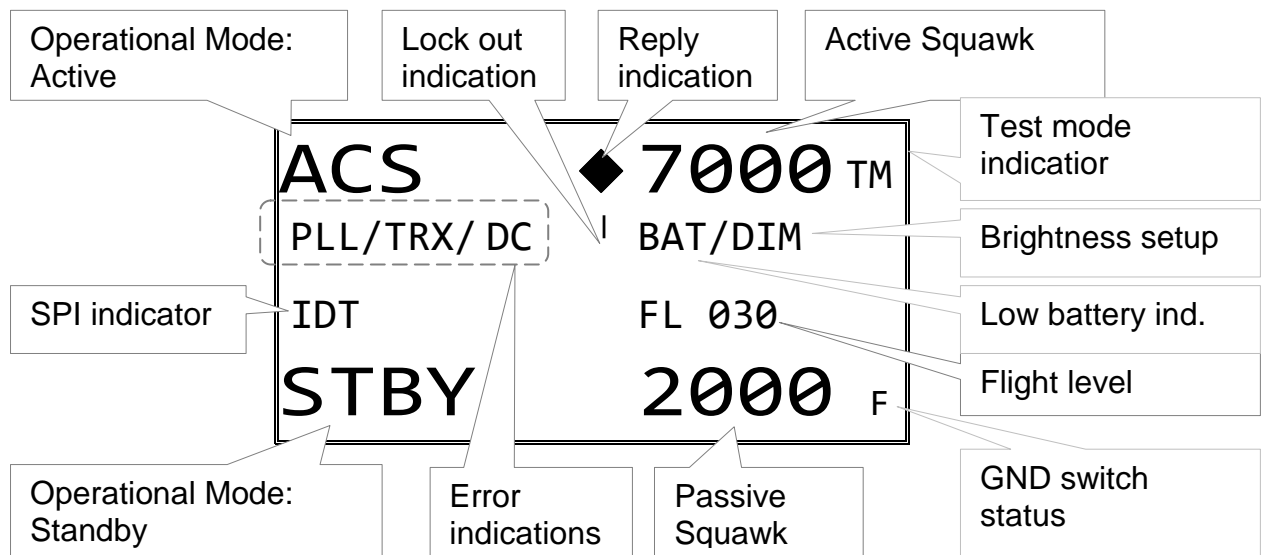

Value	Meaning	Remarks
7000	active Squawk	
2000	Standby Squawk	Could be changed with active Squawk by pressing ● ▲ ▼
FL 030 FLerr	Flight Level Invalid altitude measuring	Flight Level (in 100 ft steps) Beyond -1000 ... 35 000 ft, C Mode gets inactive
ACS	Operational Mode (STBY, A-S, ACS, AC, A)	Modes see section 2.6
IDT	transmits Ident-Marking (SPI)	ID („Squawk Ident“) has been pressed – active for 18 s
◆	Transponder replies on Mode-S, Mode-A or Mode-C interrogations	No indication on ADSB and squitter transmission
	Transponder is locked by a ground station and will be directly addressed	Lock Information (indicated below the diamond)
F G	in-flight on-ground	Ground-Switch-Info (if installed/available)

Value	Meaning	Remarks
Error indicators		
PLL	PLL Error	Internal Error
TRX	Transmit Failure	Check antenna and wiring
DC	Low internal voltage	Internal error
FPG	FPGA-Failure	Internal error
BAT	Battery Power too low	maybe battery/generator fault

2.4 Display-Brightness

In active mode (not standby) press  for 2 s

Display indicates "DIM" → Adjust brightness (DIM) with rotary knob

Return to normal operation: press  or wait 5 s.

2.5 Flight-ID (FID)

The FID is an identifier required for Mode S Operation. During future application of flight plans a FID could be assigned on a per flight basis. If no FID is assigned (today's normal case) the registration marking of the aircraft should be used as FID. The FID should not contain dashes or blanks. The FID must not be confused with the 24-bit Aircraft Address.

2.5.1 Display Flight-ID

Press  **MODE** (repeatedly) until „STBY“ appears

Press and hold  **ID** while a counter is shown beside the active squawk.
 During a few seconds Flight Identification is displayed



Operation and Installation

2.5.2 Configure Flight-ID

Press ● **MODE** (repeatedly) until „STBY“ appears

Press and hold ● **ID** while a counter is shown beside the active squawk.

Release ● **ID** when “CHANGE FID” is displayed

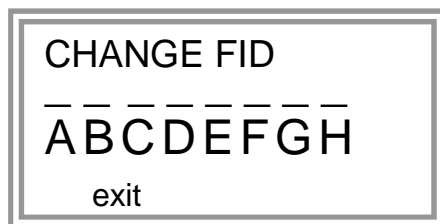

Enter Flight-ID with cursor button ●▶ and rotary knob

	<p>Enter FID <u>left-aligned, without any blanks or dashes (!)</u>, e.g. 12345621DEF^AV for the marking D-EFAV. The last remaining digits shall be filled with blanks</p>
--	---

Press ● **MODE** to save and return to STBY

Please refer to section 4.5.4 for configuration of the 24-bit Address (AA) and Aircraft Category (AC).

2.6 Transponder Mode selection

Press ● **MODE** (repeatedly) to select from following Modes:

- **STBY** → „Standby“
Transponder does not respond to any interrogation. Squitter and ADS-B output is not active.
- **A C S** → „Mode A+C+S“
Standard condition; transponder responds to mode A, C and S interrogations.
- **A – S** → „Mode A+S, no C“
Altitude is not transmitted (neither on C nor on S requests). All other Mode-S data as well as Mode-A replies are transmitted.

If no 24-bit address (AA) was defined or entered as "000000" the transponder operates as a Mode A/C transponder, in that case the following Modes are possible apart from Standby:

- **A C –** → „Mode A+C“
Transponder replies only on Mode A and Mode-C interrogations.
- **A – –** → „Mode A“
Transponder replies only on Mode A interrogations.





In STBY (Standby) mode, all transponder transmissions are disabled completely! Therefore, the transponder is not visible in this mode to air traffic control or the anti-collision systems onboard other aircrafts.

Never use the STBY mode in flight unless you are requested to do so by air traffic control. Always remember to put the transponder in active mode prior to take off!

2.7 Squawk-Setting

The active Squawk is displayed in the upper line, while the standby Squawk is presented at the lower line.

Setting the Standby Squawk:

- Press  to set the cursor („^“), turn rotary knob to set numbers of the standby Squawk.
- Press   to activate the Standby Squawk (this moves the current active Squawk into Standby)

2.8 VFR – Squawk

The transponder features a user-defined squawk code for VFR-flight (factory setting: 7000):

- Activate VFR-Squawk:
Press  **VFR** („VFR“ is indicated), now the active Squawk is moved into Standby but not visible because the indication of the Standby Squawk is overlapped by „VFR“

Operation and Installation

- Display Standby Squawk:

Press **VFR** or **▼▲** or use the **rotary knob** (the VFR-Squawk remains active!)

Example:

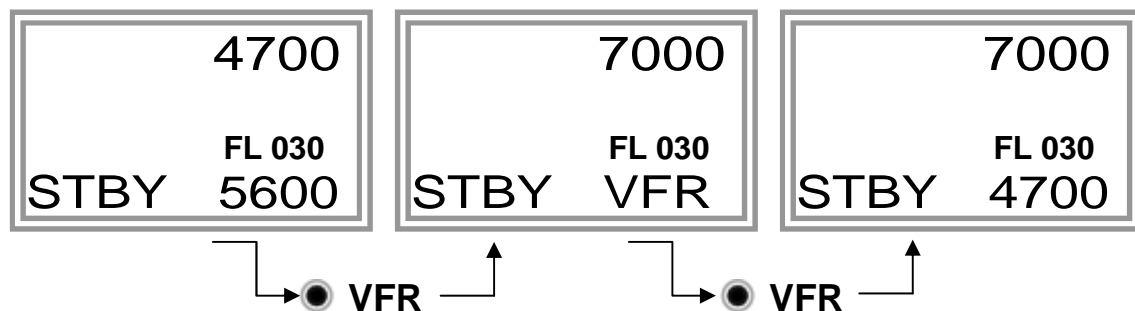

- Now the Standby Squawk can be adjusted by using the **rotary knob** and activated with **▼▲**.
- In order to store the current active Squawk as new VFR-Squawk (replacing the factory setting 7000):
Press and hold **VFR** until an „S“ is indicated (approx. 3 s); after releasing the button „VFR“ is shown

2.9 ID – Special Position Identification (SPI): “Squawk Ident”

Press ID to activate transmission of the special position identification pulse with every reply within 18 seconds; “IDT” appears on the display

By pressing **ID** a special position identification pulse (SPI) is transmitted with every reply within 18 seconds, which causes an accented marking on the Controller’s screen. The „Special Position Identification“ has to be activated after the „Squawk Ident“ request of the Controller.

2.10 Error-Codes

Please refer to 2.3 Display - Indications for possible displayed errors.

3 INSTALLATION

3.1 Notes

The following suggestions should be considered before installing.

The assigned installation company will supply wiring. For diagrams refer to 3.7 Wiring.

Transponder, External Memory, all cables and antennas shall be installed according to „FAA AC-143.13-2A *Acceptable Methods, Techniques and Practices – Aircraft Alterations*“ and the appropriate manufacturer’s instructions.

3.2 Telecommunication data

Manufacturer:	f.u.n.k.e. AVIONICS GmbH
Type Designation:	TRT800H
EASA Number:	EASA.21O.269
Transmitter Power Output	126 W
Frequency:	1090 MHz
Emission Designator:	12M0M1D

3.3 Scope of Delivery

Item name/number	Description
TRT800H	Transponder TRT800H
TRT800EMSS	External Memory (Aircraft-Address-Adaptor with wiring)
M4X8ZSW (3 pieces)	screw for panels up to 5 mm thickness
56S101A4	TNC antenna connector
03.2126.010.71e	Manual „Operation and Installation“
	EASA Form 1

3.4 Unpacking and Inspecting of the Equipment

Carefully unpack the equipment and inspect for transport damages. If a damage claim has to be filed, save the shipping container and all packing materials as evidence to your claim.

	For storage or reshipment the original packaging should be used.
---	--

3.5 Mounting

- In cooperation with a maintenance shop, location and kind of the installation are specified. The maintenance shop can supply all cables. Suitable sets of cables are available from f.u.n.k.e. AVIONICS GmbH.
- Select a position away from heat sources. Provide space for adequate convection cooling.
- Leave sufficient space for the installation of cables and connectors.
- Avoid sharp bends and wiring close to control cables.
- Leave sufficient lead length for inspection or repair of the wiring of the connector (containing the memory), so that when the mounting hardware for the rear connectors is removed, the assembly may be pulled forward several inches.
- Bend the harness at the rear connectors to inhibit water droplets (formed due to condensation) from collecting in the connector.
- For mounting details/drawing refer to chapter 3.12.2 Mounting Advices.

3.6 Equipment Connections

3.6.1 Electrical Connections

One 15 pin D-SUB miniature connector includes all electrical connections, except for the antenna. Use only an External Memory Adapter TRT800EMxx as this is part of the certification and includes a memory device in which the ICAO 24-bit Aircraft Address is stored.

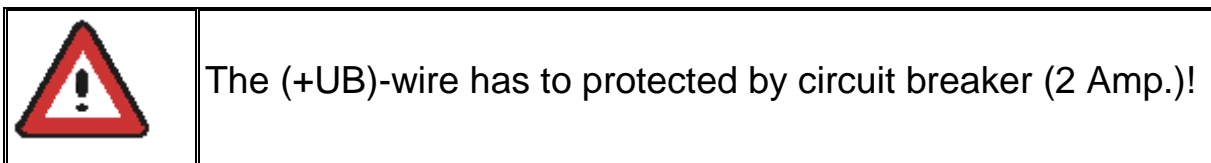

3.6.1.1 Mutual Suppression

Other equipment on board (e. g. DME) may transmit in the same frequency band as the transponder.

If such a device is installed a suppression wiring shall be installed in order to protect the receiving parts of the different devices from in-band transmissions.

Mutual suppression is a synchronous pulse that is sent to the other equipment to suppress transmission of a competing transmitter for the duration of the pulse train transmission. The transponder transmission may be suppressed by an external source and vice versa.

To activate mutual suppression connect the SUPP_I/O signal to the according signals of the other equipment

3.6.1.2 Ground Switch

If an external Ground-Switch is connected to the transponder and activated in the setup, the transponder can detect if the aircraft is airborne or on the ground. This allows the transponder to automatically activate the Ground mode whenever the aircraft is on ground.

In order to activate this feature, the input „FLY-GND“ must be connected to an external switch which connects the input pin with „GND“ when the gear is weighted, or remains open in the other case.

This feature must additionally be activated in the Setup. For details on configuration please refer to section 4.5.4.

3.6.1.3 Auto-On

The Auto-On input allows to define how the transponder will behave when power is supplied to it.

If the aircraft is equipped with a dedicated avionics master switch that switches the power supply to the transponder, the pin "Auto-On" must be wired together with the UB+ pin to the avionic master switch. The on/off button on the transponder is without function in that case. The transponder will start automatically whenever power is supplied.

On aircraft without such an avionics master switch, the pin "Auto-On" must be left unconnected. In this case, the transponder must be switched on and off via the transponder's on/off button on the front panel.

3.6.2 Static Air Port

Install a silicon soft tube fitting the 5 mm static air hose at the backside of the transponder and secure plumbing with appropriate clamps.

3.7 Wiring

3.7.1 Conductor Cross Section

Power Supply (Power, GND): AWG20 (0,62 mm²)

Signals: AWG22 (0,38 mm²)

The conductors must be approved for aircraft use.

3.7.2 Pin Assignment

	The transponder may only be operated together with an external memory address adaptor TRT800EMxx
---	--

Pin	Signal	Remarks	Adaptor	Adaptor	Adaptor
			Typ ⁽⁴⁾ TRT800 EM	Typ ⁽⁴⁾ TRT800 EMSS	Typ TRT800 EMRS
1	GND	-	●	●	●
2	Remote control ⁽¹⁾	Input	/	/	●
3	EEPROM Signal	TRT800EMxx internal	/	/	/
4	EEPROM Signal	TRT800EMxx internal	/	/	/
5	TX RS-232	Serial Output	○	●	●
6	Switched +UB ⁽¹⁾	Output	○	○	●
7	Remote control ⁽¹⁾	Output	/	/	●
8	+UB power supply	Input	●	●	●
9	GND	-	●	●	●
10	EEPROM VCC	TRT800EMxx internal	/	/	/
11	EEPROM GND	TRT800EMxx internal	/	/	/
12	RX RS-232	Serial Input	○	●	●
13	Suppression	Input / Output	○	●	●
14	Auto-On ⁽²⁾	Input ⁽²⁾	●	●	●
15	Fly-GND Switch ⁽³⁾	Input ⁽³⁾	○	●	●

● = in the plug and get out ○ = in the plug and not get out
/ = internal connection to the device

(1)	SWITCHED +UB OUT, Interface Remote control	May only be used for compatible f.u.n.k.e. AVIONICS devices. Do not connect pins if interface is not used.
(2)	Auto-On	Connect to +UB override front panel on/off button. Leave unconnected to use front panel on/off button.
(3)	Ground Switch/ FLY-GND	If an external Ground Switch is connected, it must connect this pin to GND to indicate the on-ground condition. Leave open otherwise.
(4)	Adaptors TRT800EM & TRT800EMSS	Adaptor version does not provide full interface capability (see table for details).

3.7.3 Cable plan External Memory EM800

3.7.3.1 Cable plan TRT800EMRS (older version with interface remote) to S/N 90932013

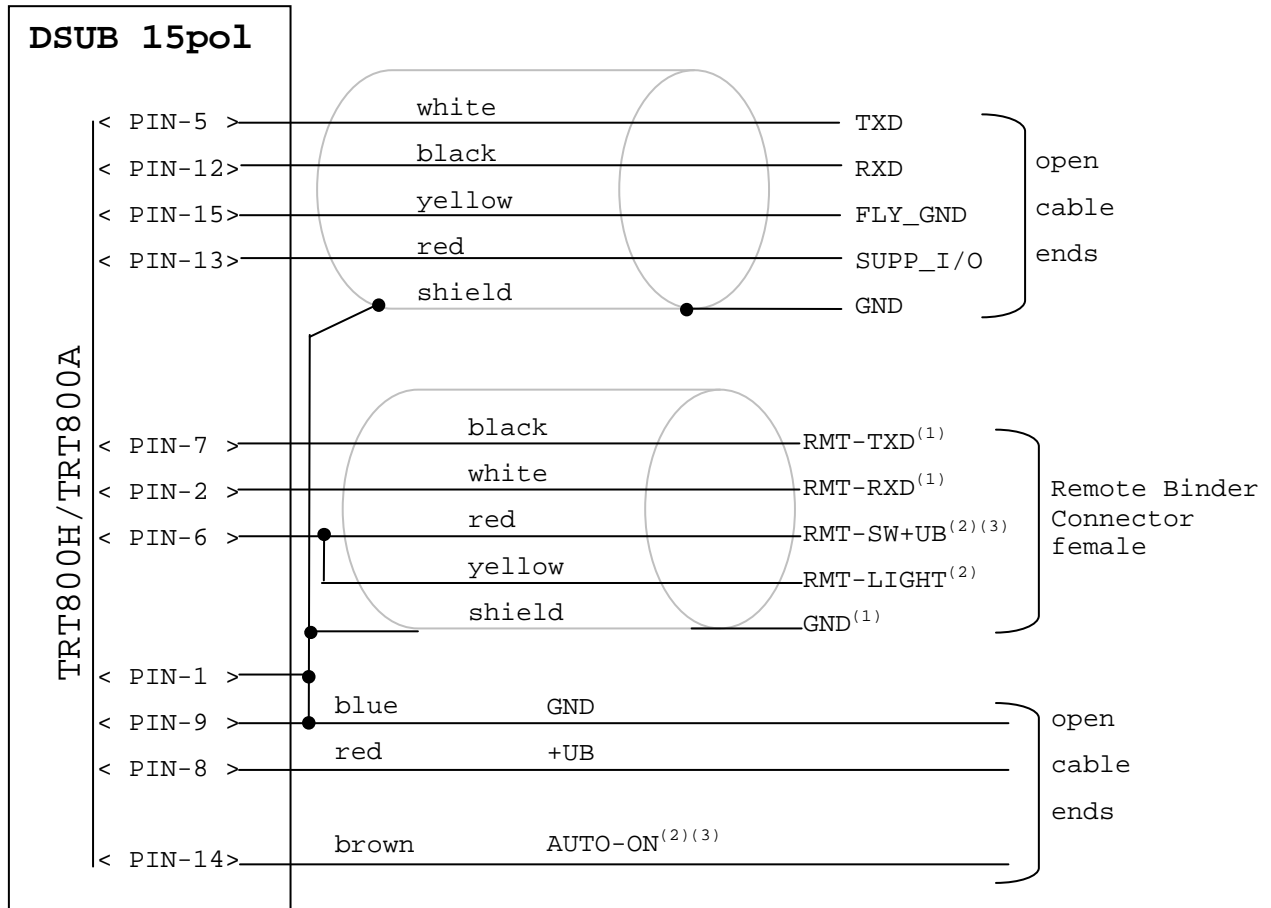

¹ New interface available
 -at TRT800H starting from S/N: 30430109 with SW V5.3
 -at TRT800A starting with SW V5.3

² New TRT800H interface starting from HW 6.0

³ port / function not available at TRT800A

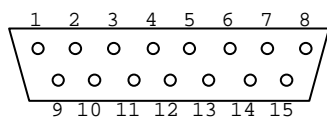

D-SUB Connector female
(solder side)

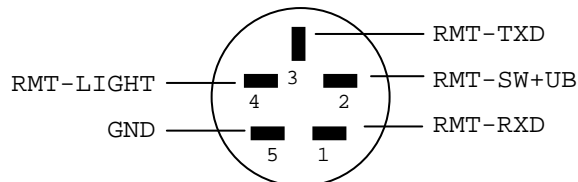

Binder Connector female
(solder side)

3.7.3.2 Cable plan TRT800EMRS (newer version with interface remote)
from S/N 90932114

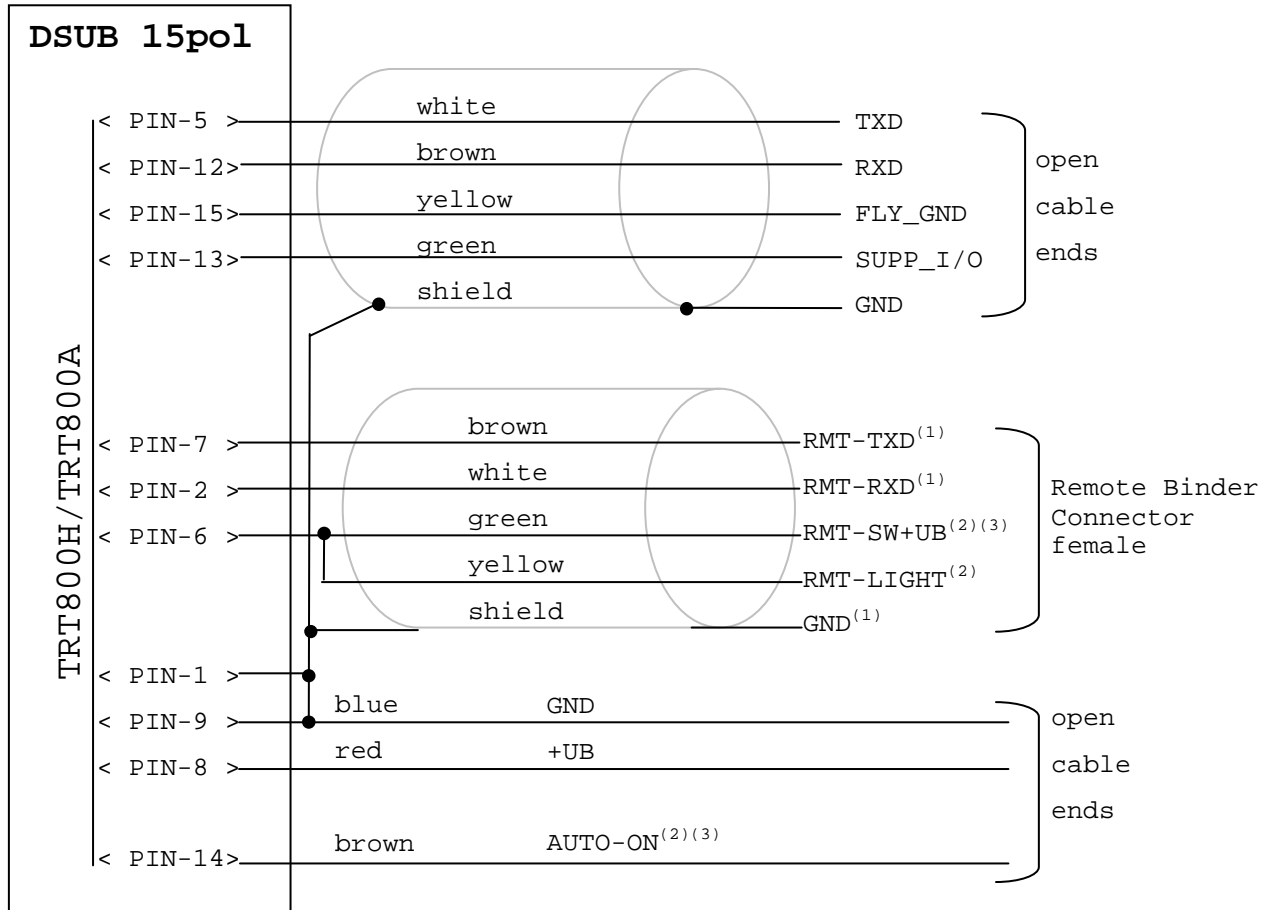

¹ New interface available
 -at TRT800H starting from S/N: 30430109 with SW V5.3
 -at TRT800A starting with SW V5.3

² New TRT800H interface starting from HW 6.0

³ port / function not available at TRT800A

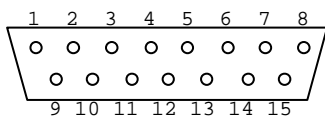

D-SUB Connector female
(solder side)

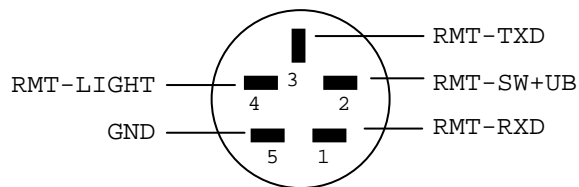

Binder Connector female
(solder side)

3.7.3.3 Cable plan TRT800EMSS (newer version without interface remote)

from S/N 91032115

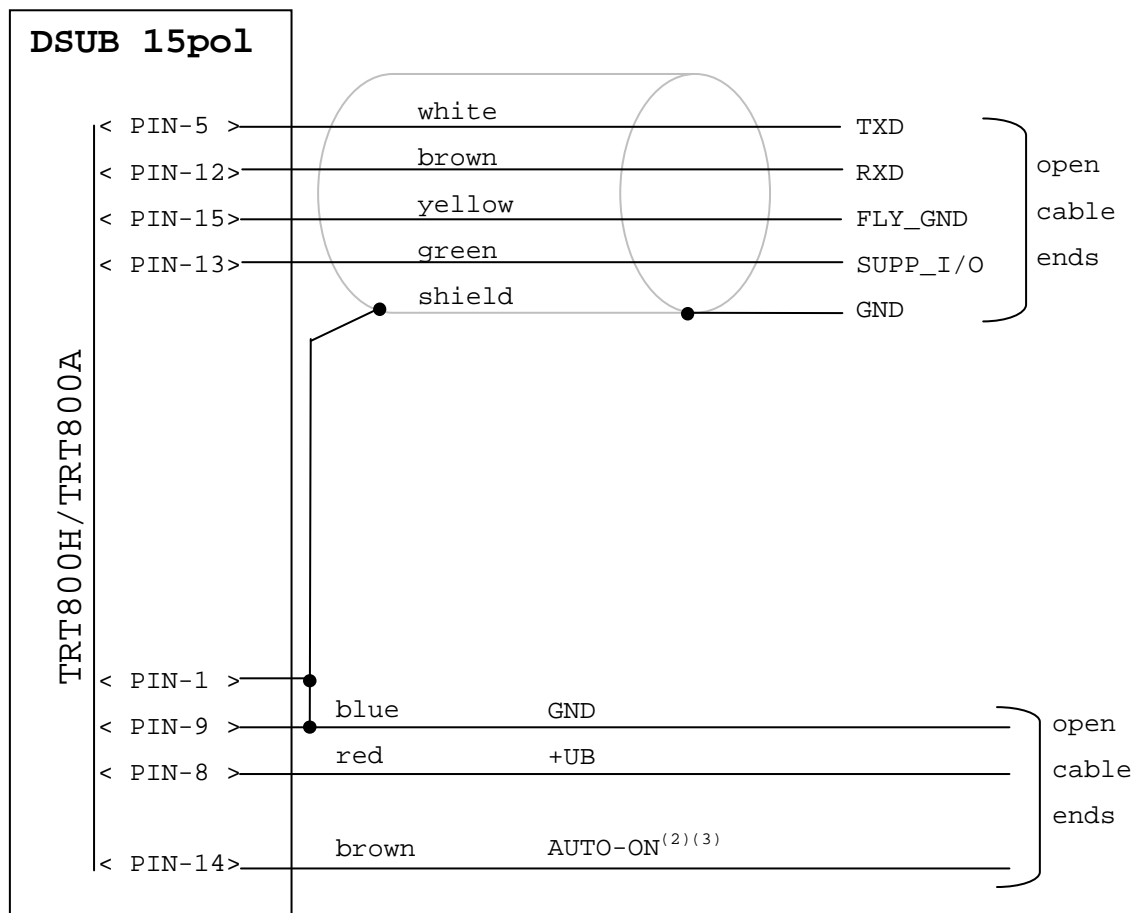

² New TRT800H interface starting from HW 6.0

³ port / function not available at TRT800A

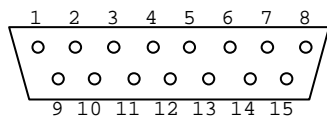

D-SUB Connector female
(solder side)



The External – Memory – Address - Adapter TRT800EMxx contains electronic parts and must not be opened. Opening or modifying the connector leads to the loss of airworthiness certification!

3.8 Antenna

3.8.1 Antenna Selection

- Recommended antennas: see section 3.11 Accessories
- Choose an antenna type compatible with the vehicle and the mounting location.
- Specified features depend on proper installation of the antenna.
- The radiation pattern needs to be verified considering aircraft type and mounting location.
- The electrical interference between the antenna and any other equipment must be taken into account in such a way that no reduction of the performance of any other system will occur.
- Install only certified antennas!

3.8.2 Installation Recommendation

- Take note of the antenna manufacturer's instructions.
- The usually deployed Dipole- or Blade antennas necessarily require a high frequency capable solid metal ground plane at the antenna base.
- For installation in composite aircrafts, ground planes are to be added. The ground plane should be as large as possible but in any case not smaller than 10 cm x 10 cm. If in doubt, please contact the aircraft manufacturer.
- Keep away three feet from any other antenna.
- Pursue mounting in vertical position under the belly in flight direction.

3.8.3 Antenna Wiring

- Suitable antenna cables: see section 3.11 Accessories
- Keep wiring as short as possible.
- The smallest cable bend radius is 10cm. Avoid sharp bends.
- Keep away from an ADF antenna cable at least 12 inches.
- Electrical connections to the antenna shall be protected against moisture to avoid loss of efficiency.



Attenuation from antenna to transponder at 1090 MHz must not exceed 1.5 dB!

3.9 Post-Installation Check



A certified maintenance shop must verify proper operation of the transponder by testing in accordance with *Appendix F of "14 CFR Part 43 – ATC Transponder Tests and Inspections"*.



All steering and control functions of the aircraft are to be examined, in order to exclude disturbances by the wiring.

The most important factor in the transponder configuration is the setting of the ICAO address (see section 4.5.4).

3.10 Starting Up

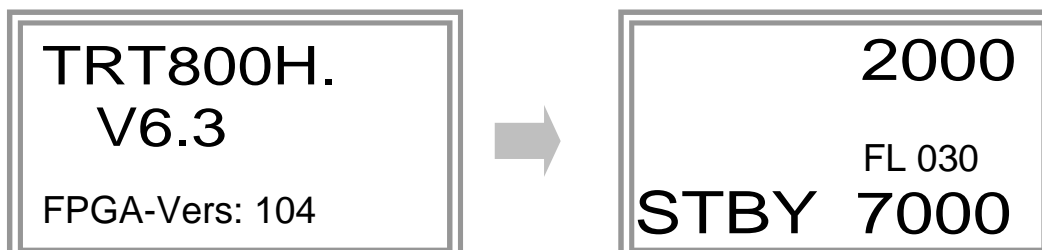
Turn the transponder on with  **I/O**. After start-up the following screens appear (example):



	<p>The TRT800H starts in standby mode (indicated with STBY). In order to change into operational mode (indicated with ACS) press  MODE . If ground switch is connected and status “in flight” is selected TRT800H starts in active mode.</p>
---	--

	<p>Very important is the correct configuration of the 24bit Aircraft-Address (see 4.5.4 General Setup).</p>
--	---

3.11 Accessories

Part Number	Description
TRKABEL1	Antenna cable 1,0 m (3.2 ft) TNC → BNC
TRKABEL2	Antenna cable 2,5 m (8.2 ft) TNC → BNC
TRKABEL3	Antenna cable 4,0 m (13.2 ft) TNC → BNC
TRKABEL4	Antenna cable 6,5 m (21.3 ft) TNC → BNC
TRT800EMRS	External-Memory (Aircraft-Address-Adaptor) Connection cable with interface TRT-Remote control
CI-105	Transponder/DME Antenna TSO C66b, C74c CI105 Comant Industries Inc. Height: 3,25”, Weight: 90 g (0.2 lbs)
AV22	Transponder Rod antenna TSO C74c AV-22 R A Miller Industries

3.12 Drawings

3.12.1 Dimensions

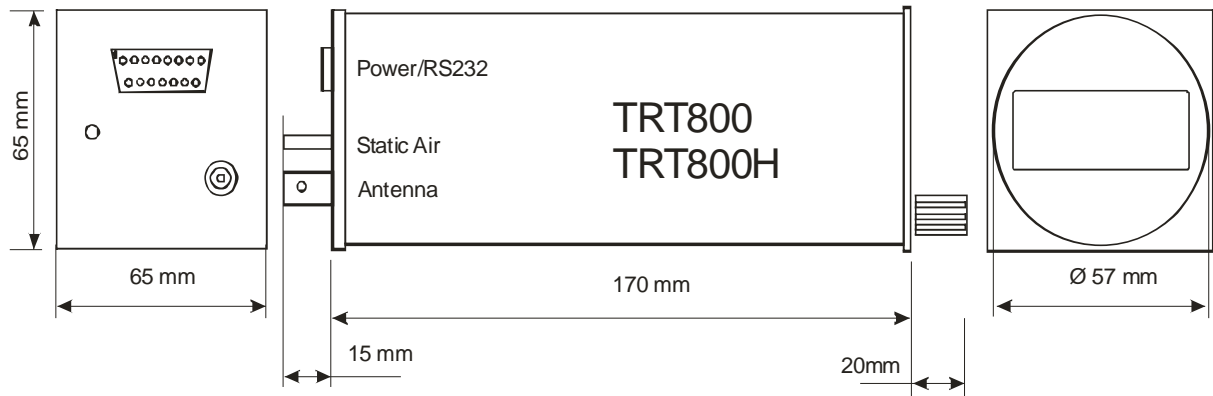

3.12.2 Mounting Advices

Connections Area

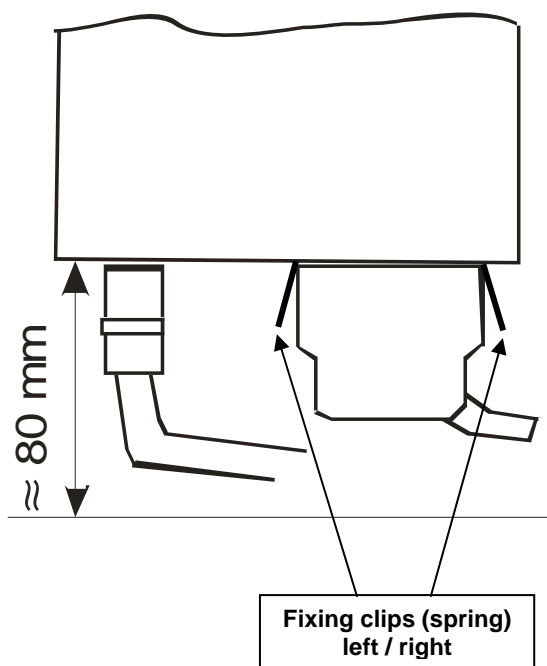

Panel Cut-out

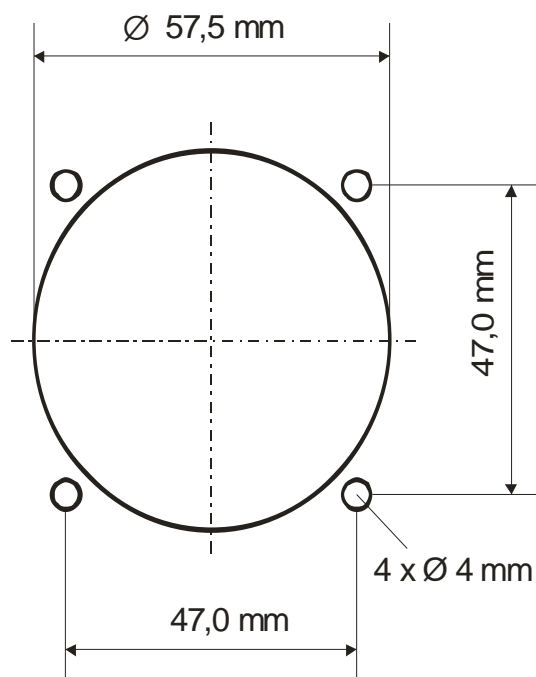

	<p>Connector (plug) has to be clamped with both spring locks. No screws may be turned in more than <u>max. 15mm</u> into the device – even if no hard limit is noticeable</p>
--	---

4 TRANSPONDER SETTINGS

4.1 Overview

The TRT800H is capable of storing the following information:

- ICAO 24-Bit Aircraft-Address (AA)
- Aircraft Category (AC),
- Flight Identification (FID)
- Ground-Switch (Yes/No)
- Speed Category (RI)
- RS232 Interface Configuration

All of these data are configurable in the Setup and are stored in the external memory module integrated within the housing of the D-Sub connector (included in the delivery).

The cable with this connector shall remain in the aircraft even if the unit is removed, to ensure that the ICAO 24bit aircraft address is fixed to the aircraft.

Additionally the following user/transponder related settings are stored transponder internally:

- Active Squawk
- Passive Squawk
- VFR Squawk
- Display contrast
- Altitude offset

4.2 Display Configuration Summary

Transponder provides the opportunity to show summary of complete current settings. To access configuration summary pages push and hold **ID** in Standby mode. Release **ID** if "SHOW SETUP" is displayed. The summary is subdivided into the following pages :

Page 1	Aircraft Address Aircraft Category Flight Identification	AA : FE1234 AC : 19 FID: 44E123 next
● MODE	↓	
Page 2	Speed Category Ground Switch option Remote Header option	Speed Cat : 8 Ground Sw.: YES Remote Hd.: NO next
● MODE	↓	
Page 3	RS-232 Settings: Protocol, baud rate, position (if available) ¹ .	RS-232: NMEA Baud : 4800 Pos. : 48.1 9.9 next
● MODE	↓	
	Integrity / Accuracy settings	Integrity/Accuracy SIL : 0 NAC : 0 next
● MODE	↓	
Page 4	Altitude correction settings (part 1)	ALTITUDE CORRECTION 2000 ft: 0ft 10000 ft: + 100ft next
● MODE	↓	

Page 5	Altitude correction settings (part 2)	<div style="border: 3px double black; padding: 5px;"> <pre>18000 ft: 0ft 25000 ft: + 100ft 35000 ft: - 50ft exit</pre> </div>
--------	--	---

Note ¹ : Position data will only be displayed if

- a GPS protocol is set (NMEA / FREEFLIGHT / ...)
- GPS receiver is connected and transmits data (if not: “Pos. :no data” is displayed)
- a valid position is transmitted (if not: “Pos. :wrong data” is displayed).

While configuration summary page is displayed no new position data will be processed.

4.3 General settings

4.3.1 ICAO 24-Bit Aircraft Address (AA)

Setup → 4.5.4

Ask your national aviation authority (e. g. in Germany: LBA, Referat B5, Department “Verkehrszulassung”) how to obtain the AA. In the case of aerial sports equipment the contact point would be the respective associations.

Only the assigned AA has to be used and must not be modified at any time, because a duplicate address would jeopardize the data surveillance and integrity figures of Mode S.



If no AA is stored, after power on the display shows “CRADLE OFF” and the transponder operates in Mode A/C.
(Configuration of the AA: see section 4.5.4)

4.3.2 Aircraft Category (AC)

Setup→4.5.4

Code	Description	Code	Description
11	Emergency Vehicle	1C	Ultra-Light / Paraglider
12	Service Vehicle	1E	Drone
19	Glider	21	Aircraft (D-Exxx) < 15.500 lbs, Motor Glider (D-Kxxx)
1A	Balloon & Airship	22	Aircraft ≥ 15.500 lbs,< 75.000 lbs
1B	Paratrooper	27	Rotorcraft



Only one of the Codes mentioned in the table above must be used.

4.3.3 Flight-ID (FID)

Setup→4.5.4

Per ICAO regulation Mode-S data must contain a valid flight identification (FID), to ensure that the correlation between flight plan and radar data will work automatically.

FID setting is required to correspond to the aircraft identification that has been specified at item 7 of the ICAO flight plan. It contains seven characters at a maximum (left-aligned, no additional zeros, dashes or spaces/blanks.)

For an aircraft using a company call sign, the Flight-ID mostly consists of the ICAO three-letter designator for the aircraft operator, followed by an identification code, e.g. KLM511, BAW213, JTR25.

If no company call sign is used or no flight plan is filed, the default FID to be set consists of the registration marking of the aircraft (e.g. DEABC) with no dashes, spaces/blanks or additional zeros, even if they are included in the registration marking on the aircraft (tail number). While entering the FID into the transponder the last remaining digits must be filled with blanks.

Operation and Installation

	<p>The ICAO Flight Plan only specifies 7 characters for FID. f.u.n.k.e. AVIONICS GmbH reserves 8 characters as stated in ED-73B for further expansion of the flight plan.</p> <p>The user shall only program 7 characters for FID.</p>
---	--

4.3.4 Reply Information - Speed Category (RI)

Setup→4.5.4

Besides AA, AC and FID another important part of the Mode-S data is the Speed Category of the respective aircraft. This speed category shall be configured in the setup and must contain one of the following codes.

Code	Description
08	No maximum airspeed data available.
09	Maximum airspeed ≤ 75 kt
10	75 kt > maximum airspeed ≤ 150 kt
11	150 kt > maximum airspeed ≤ 300 kt
12	300 kt > maximum airspeed ≤ 600 kt
13	600 kt > maximum airspeed ≤ 1200 kt
14	Maximum airspeed > 1200 kt
15	Not assigned

4.4 Optional settings

4.4.1 Option Ground-Switch

Setup→4.5.4 *Wiring*→3.7.3

If a ground switch is connected (and enabled in setup) the transponder is able to determine on-ground and in-flight state. On-ground state is activated automatically once the gear touches the ground. On-ground state is indicated on display by symbol 'G' (apart from 'F' for In-flight-state).

In On-ground-state, the transponder will reply differently to certain addressed interrogations. Also, the transmission rate of some

periodically sent data (squitters, ADS-B) is reduced. This allows ATC to distinguish between airborne aircraft and those on the ground and it reduces the Mode S channel load.

For small aircraft, authorities normally do not require such a ground switch. In this case, the transponder will use the same data formats on the ground as in the airborne state.

4.4.2 Option Remote Header

Setup→4.5.4 *Wiring*→3.7.3

The transponder provides a TRT800RT remote control interface. If a remote header TRT800RT is connected the transponder can be remotely controlled via this interface. The remote interface provides control of all standard user inputs available during standard operational mode. For more information see the TRT800RT manual.

Remote control interface de-/activation is configurable. In flight, the remote control interface must only be connected to TRT800RT, only.

For ground testing, an additional option “TEST” can be selected. This activates a remote control interface protocol for “on ground” maintenance and test purposes.

Serial Interface (RS232)

Using serial interface a GPS receiver can be connected to broadcast own position via ADS-B Out position received by other appropriately equipped aircrafts and processed for collision avoidance ADS-B Out functionality. *Setup*→4.5.4 *Wiring*→3.7.3

Information on connecting an external GPS to the TRT800H for ADS-B Out:

An external GPS receiver can be connected to the serial interface in order to enable the transponder to transmit own aircraft position as ADS-B messages.

Operation and Installation

The serial data interface of the GPS receiver is connected to RX (Pin 12, brown) and Ground (Pin 1,9, blue) of the 15 pin D-SUB connector. These pins are usually led out as open ends of the wiring harness.

The standard setting for most GPS receivers is NMEA 4800 baud. If NMEA_RAIM or FREEFLIGHT is selected static Source Integrity Level (SIL) and Navigation Accuracy Category (NAC) can be configured additionally. How to change configuration settings is described in the manual chapter 4.5.4

Important FAA-Note:

	<p>The ADS-B function of this device has not been evaluated during the FAA TSO certification process other than to ensure non-interference. Due to the SW assurance of DAL "D", the ADS-B function cannot be used in the US National Airspace.</p> <p>Connecting a GPS source will not comply to FAA certification requirements with regard to ADS-B.</p>
---	--

Supported GPS formats/protocols are:

Option	Description	Baud rate
FREEFLIGHT	GPS/WAAS Sensor 1201 NexNav NNL 3101	19200
AR-NAV	Bendix King KLN 89B, KLN 94: "Standard RS232 Sentence", KMD 150: "Sentence Type 1" Garmin 400 Series: "Sentence Type 1" (with and without altitude data)	9600
NMEA_4800	NMEA-Format, data format RMC is expected.	4800
NMEA_9600	NMEA-Format, data format RMC is expected.	9600
NMEA_RAIM	NMEA-Format, data format RMC and RAIM is expected.	9600

Other (non GPS) options:

Option	Description	Baud rate
Other		
Comm-A/B-support	Data format for special purpose. An additional data link processor allows COMM-A/B operation and processing of the position information of a flight management system simultaneously	38400
Disabled	No communication via RS232 interface.	-

Static Source Integrity Level (SIL) configuration

	All necessary error rate information must be taken from the GPS receiver specifications. If no information is given in the GPS receiver specifications the SIL value must be set to ZERO.
--	--

GPS Protocol	SIL configurable	SIL Value / Meaning	
AR-NAV, NMEA_4800, NMEA_9600	No	0	Unknown
FREEFLIGHT, NMEA_RAIM	Yes	0	Error rate: Unknown or $> 10^{-3}$ per flight hour
		1	Error rate: $< 10^{-3}$ per flight hour

When the SIL value is set to 1 the SDA value in the ADS-B transmissions will also be set to 1. Therefore, the SIL value may only be set to 1 if the requirements for transmitting SDA=1 are fulfilled, i.e. if the GPS receiver has a Design Assurance Level of at least "D".

"Navigation Accuracy Category" (NAC) configuration

	<p>The NAC value can only be configured if the GPS protocol is set to either FREEFLIGHT or NMEA_RAIM. In this case, one can choose either "0" (unknown accuracy) or "AUTO" (NAC will be set according to the data provided by the GPS receiver).</p> <p>For all other protocols, the NAC value will automatically be set to 0.</p>		
GPS Protocol	NAC configurable	NAC setting	
AR-NAV, NMEA_4800, NMEA_9600	No	0	Unknown Accuracy
FREEFLIGHT, NMEA_RAIM	Yes	0	Unknown Accuracy
		AUTO	NAC is set automatically based on GPS receiver provided data.

	<p>Setting for all described GPS-systems: 1 ... 2 position messages per 2 sec.</p>
---	--

4.4.3 Altitude Correction/Offset *Setup*→4.5.5

The TRT800H has an integrated, temperature compensated high-precision pressure sensor. This sensor is factory-calibrated so that it will yield accurate flight level (uncorrected pressure altitude) within the entire altitude range.

However, due to differences in calibration of the TRT800H pressure sensor and the altimeter in the cockpit, it may become necessary to adjust the TRT800H pressure readings so that the value indicated and transmitted by the TRT800H corresponds to the indication of the primary altimeter seen by the pilot within 125 feet (as specified in ETSO C88a/SAE AS 8003).

The check for correspondence between the primary altimeter and the TRT800H is usually performed every 24 months as part of the aircraft's altimeter checks.

Altitude correction is based on setup configurable offset values at five interpolation points (2,000, 8,000, 18,000, 25,000 and 35,000 ft). The offset value itself is limited to a range from -100 to + 100ft at each point (10ft steps).

4.5 Setup Procedure

	<p>Programming of the ICAOA 24-bit Aircraft Address and of the Aircraft Category shall be executed by <u>qualified personnel</u> only!</p> <p>A wrong Aircraft Address or Flight ID may cause serious problems ATC or with ACAS/TCAS systems!</p> <p><u>Pilot and owner</u> are responsible for correctly set transponder data.</p>
---	---

4.5.1 Setup Menu Control

In order to access the functions described in the following paragraphs push and hold **●ID** in Standby mode. Release **●ID** if desired counter value/ menu name is displayed to enter the menu. The following menu entries are selectable:

Count	Displayed Name	Function
0..3	FID	FID is displayed
4..8	CHANGE FID	Enter FID setup page
9..13	SHOW SETUP	Enter setup summary listed on different pages (no changes possible)
25..28	ENTER SETUP	Enter transponder general configuration pages
31..34	ALTITUDE CORRECTION	Enter altitude correction menu

4.5.2 Transponder configuration/record structure

Aircraft related parts of transponder configuration are stored in one out of eight possible records (record=presetting). Each record contains the following information:

- Aircraft Address (AA, 24bit)
- Aircraft category (AC)
- Flight identification (FID, 6-8 numbers/letters)
- RS-232 Interface setting (eg. GPS protocol)
- Ground-Switch setting (Installed Yes/No)
- Speed category (RI) of the respective aircraft
- Remote Header setting (Installed Yes/No)

User related settings (e.g. squawk codes, display contrast) are stored once in one global record (transponder internally).

4.5.3 Transponder configuration/record handling

At least one record is stored in external memory. Up to 8 records can be additional be applied during setup process.





If more than one record is applied, the active record must be selected out of a list (determined by FID) during start-up of the transponder.



Previously applied records can be deleted again by filling FID with zero's only.

4.5.4 General Setup



Any menu item can be passed by **MODE**. If no changes are made the original settings will remain stored. Modification of one menu item does not impact the others. No entries will be deleted.

Step	Display (Example)
1. Start-up Transponder	
2. Ensure, the transponder-mode is „STBY“. If necessary change the mode by pressing MODE	<div style="border: 2px solid gray; padding: 10px; text-align: center;"> <p>2000</p> <p>FL 030</p> <p>STBY 7000</p> </div>
3. Press ID A counter is shown at the upper-right corner. Hold ID till “ENTER SETUP” is displayed.	<div style="border: 2px solid gray; padding: 10px; text-align: right;"> <p>ENTER SETUP 26</p> </div>
4. After release of ID the first setup menu is displayed	<div style="border: 2px solid gray; padding: 10px;"> <p>AA : EF123456</p> <p>AC : 18</p> <p>FID: ABCDEFG</p> <p>next</p> </div>
5.   /  select position (^)  rotary knobchange value	<div style="border: 2px solid gray; padding: 10px;"> <p>AA : EF123456</p> <p>AC : 18</p> <p>FID: ^BCDEFG</p> <p>next</p> </div>
↓ MODE	
6. With the rotary knob you can select „yes“ if a Ground Switch is installed, if not select “no” and proceed with step 7	<div style="border: 2px solid gray; padding: 10px;"> <p>Record 1:</p> <p>GND Switch: Yes/No</p> <p>next</p> </div>

Step	Display (Example)
<p>↓ ● MODE</p>	
<p>7. At this stage the respective speed category <u>shall</u> be selected by using the rotary knob.</p>	<div style="border: 1px solid gray; padding: 5px;"> <p>Record 1:</p> <p>Speed Cat.: 08-15</p> <p>next</p> </div>
<p>↓ ● MODE</p>	
<p>8. At this stage a GPS receiver for ADS-B Out can be selected (Selectable by rotary knob).</p>	<div style="border: 1px solid gray; padding: 5px;"> <p>Record 1:</p> <p>GPS/INT: NMEA/..</p> <p>next</p> </div>
<p>↓ ● MODE</p>	
<p>9. Configuration Source Integrity Level</p> <p>● Rotary knob changes selection</p> <div style="border: 1px solid black; padding: 2px; display: inline-block;">  <p>Only displayed when NMEA-RAIM or FREEFLIGHT is selected. Otherwise SIL=0 .</p> </div>	<div style="border: 1px solid gray; padding: 5px;"> <p>Record 1:</p> <p>SIL: 0/1</p> <p>next</p> </div>
<p>↓ ● MODE</p>	
<p>10. Configuration Navigation Accuracy</p> <p>● Rotary knob changes selection</p> <div style="border: 1px solid black; padding: 2px; display: inline-block;">  <p>Only displayed when NMEA-RAIM or FREEFLIGHT is selected. Otherwise NAC=0 .</p> </div>	<div style="border: 1px solid gray; padding: 5px;"> <p>Record 1:</p> <p>NAC: 0/auto</p> <p>next</p> </div>
<p>↓ ● MODE</p>	

Step	Display (Example)
<p>11. At this stage remote interface for communication between TRT800H and remote header can be activated (Selectable by rotary knob).</p> <div style="border: 1px solid black; padding: 5px; display: flex; align-items: center;">  <p>If no TRT800RT is connected, "No" must be selected here! The setting "TEST" is only allowed for tests on the ground.</p> </div>	<div style="border: 2px solid gray; padding: 10px; text-align: center;"> <p>Record 1: REMOTE Header: Yes/No/Test next</p> </div>
<p>↓ <input checked="" type="radio"/> MODE</p>	
<p>12. With <input checked="" type="radio"/> ID further Records can now be created and configured as described in the aforementioned steps At start-up of the transponder one of the defined records with all associated configurations need to be selected</p>	<div style="border: 2px solid gray; padding: 10px; text-align: center;"> <p>Records ID=Edit Records EXIT</p> </div>
<p>↓ <input checked="" type="radio"/> MODE</p>	
<p>13. You have now left the configuration mode and are back in normal operation.</p>	<div style="border: 2px solid gray; padding: 10px; text-align: center;"> <p>2000 FL 030 STBY 7000</p> </div>
<p>14. Switch off the transponder</p>	
<p>15. Switch on the transponder. Your ICAO 24-Bit Aircraft Address is now stored.</p>	<div style="border: 2px solid gray; padding: 10px; text-align: center;"> <p>TRT800H. V6.3 FPGA-Vers: 104</p> </div>





4.5.5 Altitude Correction Setup

Description→4.4.3

	<p>Altitude correction setup shall be executed by <u>qualified personnel</u> only!</p> <p><u>Pilot and owner</u> are responsible for correctly set altitude offset values.</p> <p>The use/setting of altitude correction values is <u>only</u> necessary in exceptional cases (see 4.4.3 for details)</p>
---	--

Altitude correction is based on five interpolation points (2000, 10000, 18000, 25000 and 35000 ft). The offset value at each interpolation point can be adjusted in a range from -100 to + 100ft at each point (10ft steps). Offset values set to zero at each interpolation point deactivates altitude correction (default/factory setting).

Step	Display (Example)
1. Start-up Transponder	
2. Ensure, the transponder-mode is „STBY“. If necessary change the mode by pressing ● MODE	<div style="border: 1px solid black; padding: 10px; width: fit-content; margin: auto;"> <p style="font-size: 24px; margin: 0;">2000</p> <p style="font-size: 18px; margin: 0;">FL 030</p> <p style="font-size: 24px; margin: 0;">STBY 7000</p> </div>
3. Press ● ID A counter is shown at the upper-right corner. Hold ● ID till “ALTITUDE OFFSET” is displayed.	<div style="border: 1px solid black; padding: 10px; width: fit-content; margin: auto;"> <p style="font-size: 18px; margin: 0;">ALTITUDE OFFSET 33</p> </div>

Step	Display (Example)
4. After release of  ID the first altitude level + corresponding offset value is displayed.	<div style="border: 1px solid black; padding: 10px; text-align: center;"> Altitude: 2000 ft Offset : 0 ft next </div>
5. Change offset value with  rotary knob	<div style="border: 1px solid black; padding: 10px; text-align: center;"> Altitude: 2000 ft Offset : 0 ft next </div>
 MODE	
6. (..9) Repeat last step for another 4 altitude levels 10000ft, 18000ft, 25000ft, 35000ft	<div style="border: 1px solid black; padding: 10px; text-align: center;"> Altitude: 10000 ft Offset : 0 ft next/exit </div>
 MODE	
10. You have now left the configuration mode and are back in normal operation.	<div style="border: 1px solid black; padding: 10px; text-align: center;"> 2000 FL 030 STBY 7000 </div>
Switch off the transponder	
11. Switch on the transponder. New altitude offset values will now be used for altitude calculation.	<div style="border: 1px solid black; padding: 10px; text-align: center;"> TRT800H. V6.3 FPGA-Vers: 104 </div>

5 APPENDIX

5.1 Technical Data

Compliance	CS-ETSO-2C112a EASA.210.269 FAA TSO-C112c
Applicable Documents	CS-ETSO-2C112a FAA TSO-C112c EUROCAE ED-73C Class 1 Level 2es RTCA DO-181D Class 1 Level 2es EUROCAE ED-26 RTCA DO-160D RTCA DO-178B Software-Level D
Temperature Ranges Operation Storage	-20 °C to +55 °C; for 30 min +70°C -55 °C to +85 °C
Altitude Range	≤ 35 000 ft
Speed Range	≤ 250 kt (TAS)
Shock	6 G Operation 20 G crash safety
Environmental Categories	RTCA DO-160D Env.Cat.: [C1Z]CAA[SM]XXXXXXZBAAA[TT]M[B3F3]XXA
Power Supply	13,8 VDC (10 VDC .. 16 VDC) 0,40 A @ 13,8 VDC (typ.) 0,70 A @ 13,8 VDC (max.) 10 W (max)

Operation and Installation

Fuse	External 2A-slow-blow fuse
Mounting	Panel cut-out d=57,5 mm
Weight	0,6 kg (1.32 lbs.)
Receiver Characteristics: Sensitivity	RF input power level resulting in a 90 % reply rate: A. MTL for ATCRBS and ATCRBS/Mode S All-Call interrogations: -74 dBm \pm 3 dB. B. MTL for Mode S interrogations: -74 dBm \pm 3 dB.
Reply transmission frequency	1090 \pm 1 MHz
Power Output	\geq 21 dBW (\geq 126 W) at antenna base (with maximum cable attenuation of 1,5 dB)
Squitter (ADS-B)	transmitted at random intervals uniformly distributed over the range from 0.8 to 1.2 seconds, full self-verification of data and occurrence
Mode S Elementary Surveillance	
ICAO 24-bit Aircraft Address (Hex-Code)	aircraft address as assigned by national aviation authority
FID	Flight ID: Flight Plan call sign or aircraft registration marking
Capability Report	Reports the available data and means by which the transponder can report.
Pressure Altitude	Up to 35 000 ft in 25 ft increments
Flight Status	in-flight / on-ground
Mode S Enhanced Surveillance	
Level 2es	Comm-A / Comm-B: 56/112-Bit-Messages SI-capability

5.2 Environmental Conditions

Characteristic DO-160D	Section	Cat.	Condition
Temperature / Altitude	4.0		
Low ground survival temperature	4.5.1	C1	- 55°C
Low operating temperature	4.5.1		- 20°C
High ground survival Temperature	4.5.2		+ 85°C
High Short-time Operating Temperature	4.5.2		+ 70°C
High Operating Temperature	4.5.3		+ 55°C
In-Flight Loss of Cooling	4.5.4		Z
Altitude	4.6.1	C1	35 000 ft
Temperature Variation	5.0	C	2°C change rate minimum per minute
Humidity	6.0	A	
Shock	7.0	A	6 G operational shocks 20 G Crash Safety Test Type R in all 6 directions
Vibration	8.0	S	Vibration Curve M
Explosion Proofness	9.0	X	No test required
Water Proofness	10.0	X	No test required
Fluids Susceptibilities	11.0	X	No test required
Sand and Dust	12.0	X	No test required
Fungus Resistance	13.0	X	No test required
Salt Spray	14.0	X	No test required
Magnetic Effect	15.0	Z	Less than 0,3 m
Power Input (DC)	16.0	B	
Voltage Spike Conducted	17.0	A	
Audio Frequency Conducted Susceptibility	18.0	A	

Characteristic DO-160D	Section	Cat.	Condition
Induced Signal Susceptibility	19.0	A	
Radio Frequency Susceptibility	20.0	TT	
Emission of RF Energy	21.0	M	
Lightning Induced Transient Susceptibility	22.0	B3F 3	
Lightning Direct Effects	23.0	X	No test required
Icing	24.0	X	No test required
Electrostatic Discharge (ESD)	25.0	A	

5.3 DO-178B Open Problem Reports

There are no open problem reports for the software of this device.

Notes:

f.u.n.k.e.

AVIONICS GMBH

f.u.n.k.e. AVIONICS GmbH

Heinz-Strachowitz-Str. 4
DE-86807 Buchloe
Germany

phone.: +49-8241 80066 0

fax.: +49-8241 80066 99

E-mail:

service@funkeavionics.de

www.funkeavionics.de